

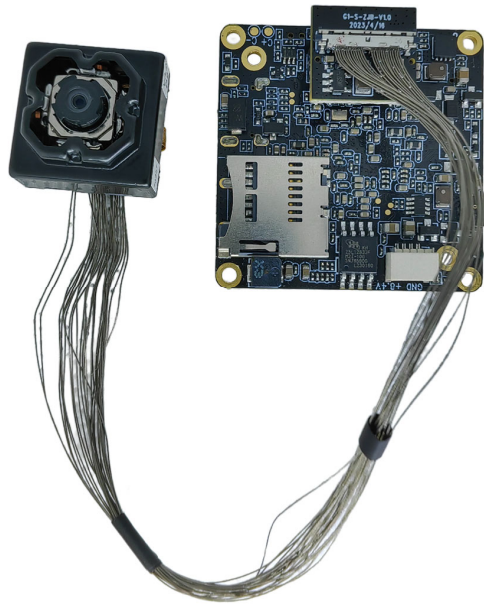

## KLT-G1M9WF3+KLT-CMAOIS-IMX258 V1.0

**Ai Master Board + WiFi Board + 13MP Sony IMX258 Auto Focus OIS Anti-Shake Camera Module Development Kit**



Sony IMX258  
光学防抖模组  
OIS Anti-shake module

26P 1对1同轴线  
Coaxial cable

BTB转同轴座转接板  
The BTB shall turn to the coaxial socket transfer plate

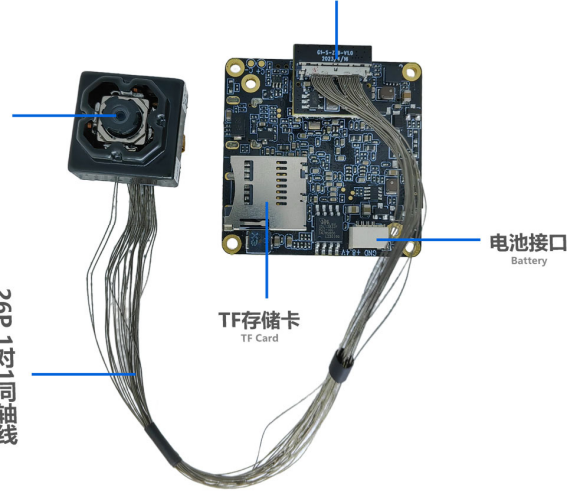

电池接口  
Battery

TF存储卡  
TF Card

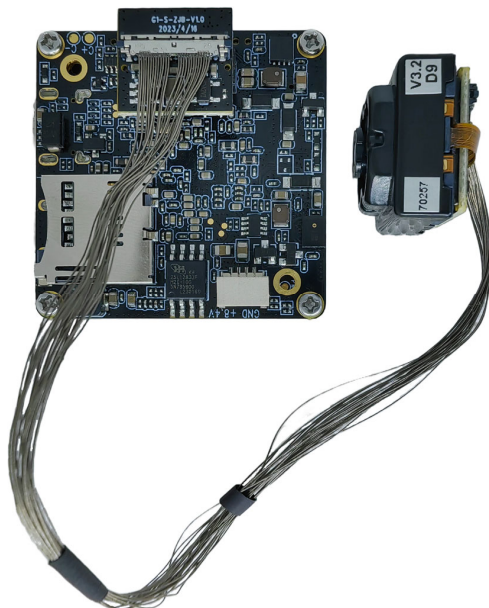

TF存储卡  
TF Card

BTB转同轴座转接板  
The BTB shall turn to the coaxial socket transfer plate

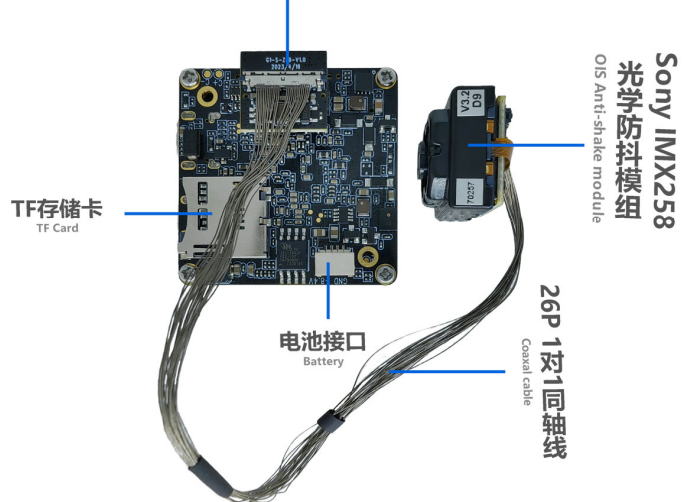

Sony IMX258  
光学防抖模组  
OIS Anti-shake module

26P 1对1同轴线  
Coaxial cable

电池接口  
Battery

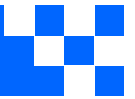

## KLT-G1M9WF3+KLT-CMAOIS-IMX258 V1.0

### Ai Master Board + WiFi Board + 13MP Sony IMX258 Auto Focus OIS Anti-Shake Camera Module Development Kit

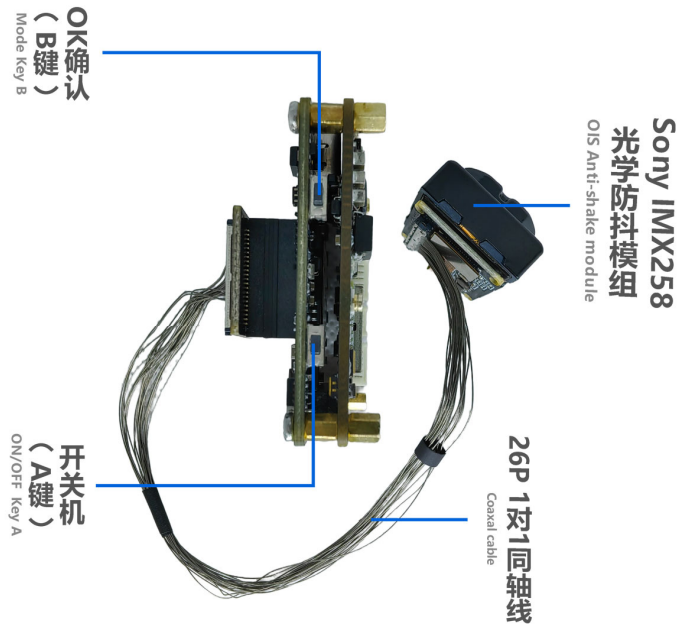
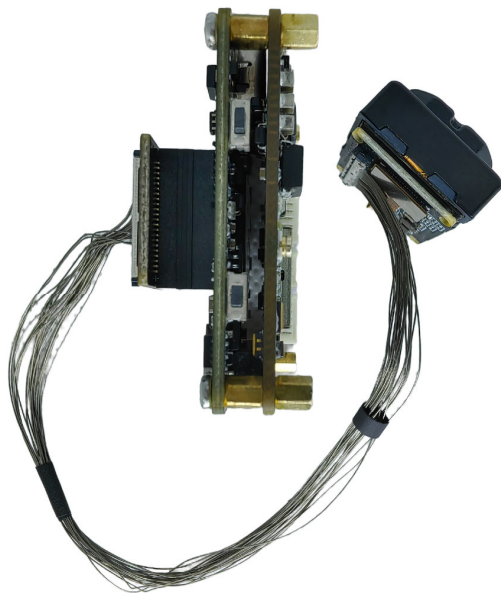
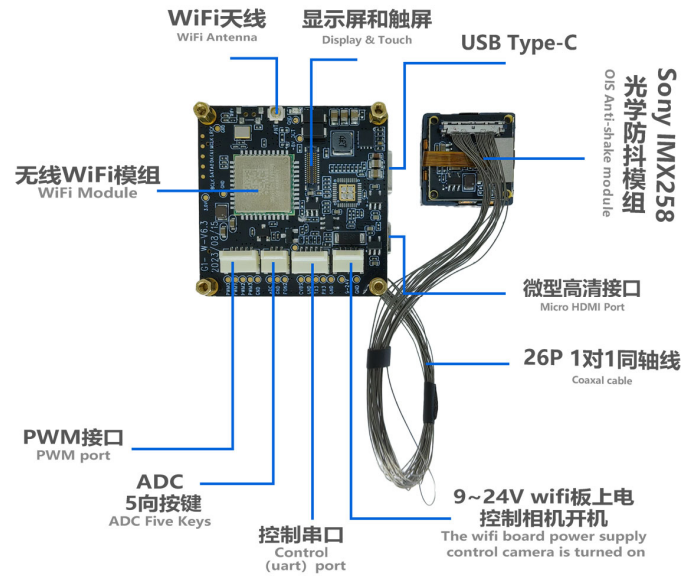
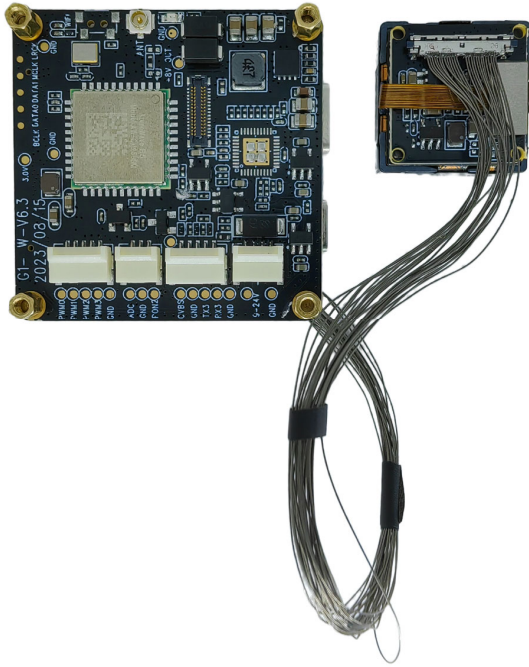



## KLT-G1M9WF3+KLT-CMAOIS-IMX258 V1.0

**Ai Master Board + WiFi Board + 13MP Sony IMX258 Auto Focus OIS Anti-Shake Camera Module Development Kit**

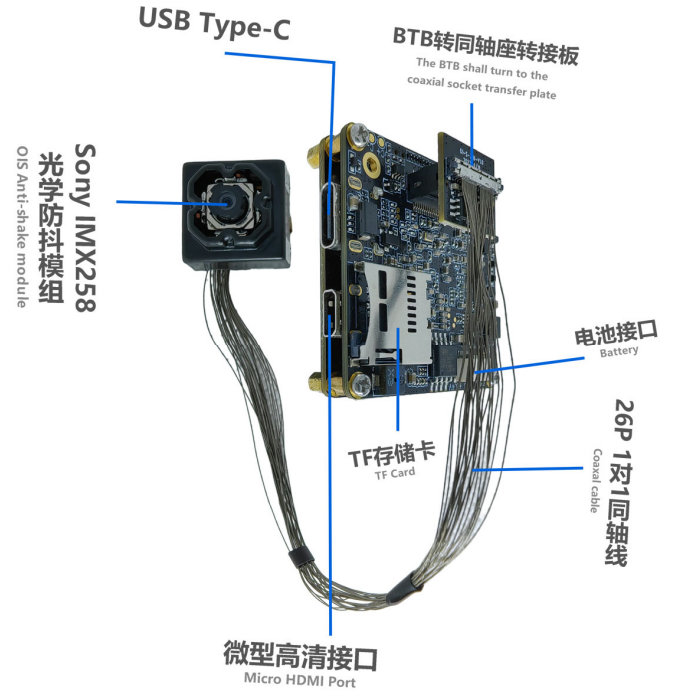
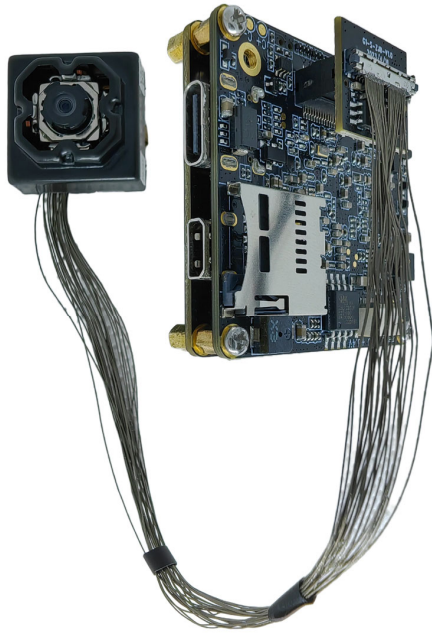

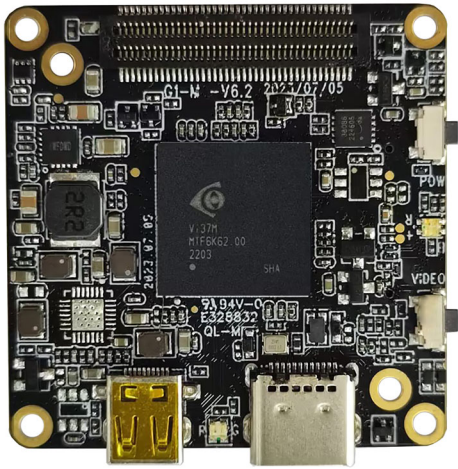

**KLT-G1M9 V6.2****iCatch V39 Ai-Powered Image Processing SoC Master Board**

Front View

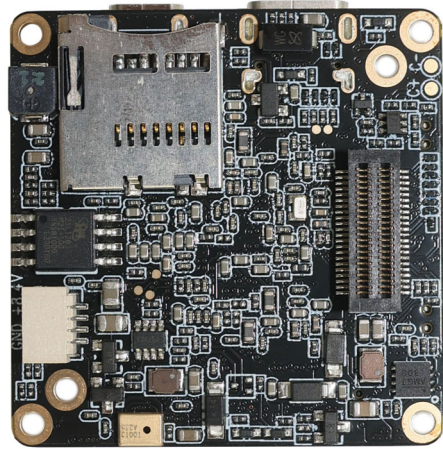

Back View

**Overview**

Equipped with iCatch V39, built-in 2GB DDR3, supports up to 4K@60FPS (differential), 4K@30FPS, 1080P@120FPS H.264 encoded video. Onboard support Type-C, HDMI, TF memory card, recording, 2 control buttons, buzzer, battery power supply, etc.

This master board extension also supports WiFi, LCD display, CVBS, lens module, UART, I2C, SPI, PWM, MIC and other expansion interfaces. The board size is 38x38mm. Widely used in drones, mini DV, wearable devices, sports cameras, face recognition, USB cameras and other camera products.





## KLT-G1M9 V6.2

### iCatch V39 Ai-Powered Image Processing SoC Master Board

#### Hardware Specifications

<b>Model No.</b>	<b>KLT-G1M9 V6.2</b>
<b>Main Control Chipset (DSP)</b>	iCatch V39
<b>Image Sensor Interface</b>	MIPI
<b>Battery Voltage</b>	7.4V - 7.7V High Voltage Lithium Battery
<b>Storage Type</b>	External TF Card, Supports 8GB - 512GB Class 10 and Above, U3 is Recommended
<b>Type-C Port</b>	Type-C USB 5V Connection to Computer USB Mode Connection to PCCAM (Camera) Mode
<b>LED Indicator Type</b>	Three Color Light (Red, Green, Blue)
<b>2 Control Button Type</b>	Power Button (A), OK Button (B)
<b>Power Supply</b>	Supports 3 Power Supply Methods At The Same Time (1) 5V USB to Type-C Port Power Supply (2) 9V-24V WiFi Board or Network Port board Power Supply (3) 6.8V-8.4V Battery Power Supply (The 3-Axis Gimbal Version Does Not Support 5V USB)
<b>Operating Temperature</b>	-10°C to +60°C Without Housing
<b>Storage Temperature</b>	-20°C to +80°C
<b>Humidity</b>	20% to 80%
<b>PCB Dimensions</b>	38 x 38 mm
<b>PCB Screw Hole Spacing</b>	External (34mm x4), Internal (28mm x2)
<b>PCB Screw Hole Diameter</b>	2 mm
<b>Optional Camera Configuration</b>	(1) KLT-G1M9 V6.2 + Camera (2) KLT-G1M9 V6.2 + Camera + KLT-G1WF V6.3 WiFi Board (3) KLT-G1M9 V6.2 + Camera + KLT-G1NK V6.3 Ethernet Board
<b>Supportive Image Sensors</b>	13MP: IMX258 12MP: IMX377 OS21D40 IMX577 IMX386 IMX378 8MP: IM317 5MP: IMX335 2MP: IMX290 IMX385
<b>Optional Extension Ports</b>	WiFi, Ethernet Network Port, Display, Audio IC, Lens Module, UART, I2C, SPI, PWM, MIC, etc.



## KLT-G1M9 V6.2

### iCatch V39 Ai-Powered Image Processing SoC Master Board

#### Photo Image Settings

<b>Resolution</b>	20MP, 13MP, 12MP, 10MP, 8MP, 5MP, 3MP, 2MP
<b>Time Lapse Photography</b>	OFF, 3S, 5S, 7S
<b>Continuous shooting</b>	OFF, 3-Shot, 7-Shot, 15-Shot, 30-Shot
<b>White Balance</b>	Auto, Sunny, Cloudy, Fluorescent, Incandescent
<b>Power Frequency</b>	50Hz, 60Hz
<b>Exposure Compensation</b>	EV 0.0, EV 3.0, EV 7.0, EV 10.0, EV 13.0, EV 17.0, EV 20.0, EV -3.0, EV -7.0, EV -10.0, EV -13.0, EV -17.0, EV -20.0
<b>Time Lapse Photo Interval</b>	OFF, 1S, 2S, 3S, 4S, 5S, 6S, 7S, 8S, 10S, 13S, 15S, 20S, 25S, 30S, 40S, 1min
<b>Time Lapse Duration</b>	No Limit, 1min, 3min, 5min, 10min, 20min, 30min, 1hr, 2hr, 3hr, 5hr
<b>Photo Time Watermark</b>	OFF, Date, Date and Time

#### Wifi、显示屏、网口、uart、PWM等扩展接口

For Wifi, Display, Network, uart, PWM Etc.

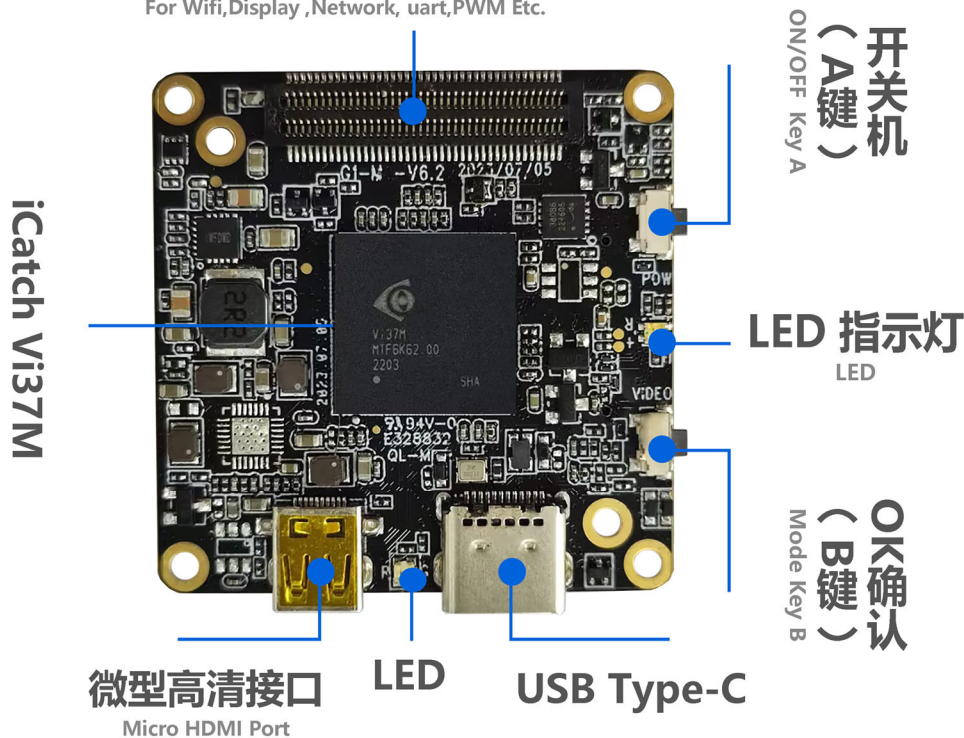



## KLT-G1M9 V6.2

### iCatch V39 Ai-Powered Image Processing SoC Master Board

#### Video Settings

<b>Resolution</b>	16:9 (4K, 2.7K, 1080P, 720P) 4:3 (1440P) Currently Only IMX377 Sensor Supports 1440P
<b>Frame Rate</b>	24FPS, 25FPS, 30FPS, 48FPS, 50FPS, 60FPS, 120FPS, 240FPS
<b>Slow Motion Recording</b>	OFF, 4K2X, 1080P4X, 720P8X
<b>Fast Motion Recording</b>	OFF, 2X, 5X, 10X, 15X, 30X
<b>Automatic Recording</b>	OFF, ON
<b>Time Lapse Video Mode</b>	OFF, 1S, 2S, 3S, 4S, 5S, 6S, 7S, 8S, 10S, 13S, 15S, 20S, 25S, 30S, 40S, 60S
<b>Time Lapse Duration</b>	No Limit, 1min, 3min, 5min, 10min, 20min, 30min, 1hr, 2hr, 3hr, 5hr
<b>Pre-recording</b>	OFF, ON (for Option ON, 5 Seconds of Video is Pre-recorded)
<b>EIS Anti-Shake</b>	OFF, ON
<b>Image Quality Enhancement</b>	Super Good, Very Good, Normal (Referral to Actual Video Effect Quality, Not for Preview)
<b>Image Rotation</b>	Normal, Vertical, Horizontal (for Recorded Video)
<b>Recording Time</b>	No Limit, 1min, 5min
<b>Automatic Screen Off</b>	OFF, 60S, 180S, 300S
<b>Light Metering Mode</b>	Center, Multi-point, Single Point
<b>Video Recording File Time</b>	No Limit, 1min, 5min
<b>Loop Recording</b>	OFF, ON
<b>Recording Volume</b>	0, 1, 2, 3
<b>Video Time Watermark</b>	OFF, Date, Date and Time





## KLT-G1M9 V6.2

### iCatch V39 Ai-Powered Image Processing SoC Master Board

#### System Settings

<b>Automatic Shut Down</b>	OFF, 1min, 3min, 5min, 10min, 15min
<b>USB Auto Power On</b>	Turn ON, Turn OFF
<b>Languages</b>	English, Simplified Chinese, Traditional Chinese (Select Language Through Configuration File in the Card)
<b>Button Touch Tone</b>	Turn ON, Turn OFF
<b>Automatically Turn On WiFi</b>	Turn ON, Turn OFF
<b>WiFi Frequency Bands</b>	2.4GHz or 5GHz (Dual Band Single Channel)
<b>Display Brightness</b>	Low, Medium, High Brightness (for Touch Screen)
<b>Display Setting</b>	Conventional Display, Full Screen Display (for Touch Screen)
<b>Fill Light A (White Light)</b>	Auto, OFF, ON (for Use with Fill Light Board)
<b>Fill Light B (Infrared Light)</b>	Auto, OFF, ON (for Use with Fill Light Board)
<b>IR Cut Settings</b>	Auto, OFF, ON (for Use with IR Cut Function Modules)
<b>Special Effects</b>	Original Image, Black and White, Natural, Negative, Warm Tones, Contrast (for Touch Screen)
<b>White Balance</b>	Auto, Sunny, Cloudy, Fluorescent, Incandescent
<b>Date and Time</b>	Year, Month, Day, Hour, Minute
<b>Format</b>	No, Yes
<b>Reset</b>	No, Yes
<b>Card Information</b>	Displays Video Card Capacity and Free Space
<b>Device Information</b>	Displays Firmware Version

#### Gimbal Functions and Settings

<b>Gimbal Functions</b>	Centering, Calibration
<b>Sensitivity</b>	Follow Softly, Follow Sensitively
<b>Follow Mode</b>	Full Follow, Heading Follow, Heading and Pitch Follow
<b>Pitch Axis Control</b>	Turn ON, Turn OFF



## KLT-G1M9 V6.2

### iCatch V39 Ai-Powered Image Processing SoC Master Board

#### Camera Features

<b>Continuous Shooting</b>	Long Press the OK Button (B) to Shoot Continuously, Release Button to Stop Shooting Continuously
<b>Snapshot</b>	During Recording, Long Press the OK Button (B) to Capture the Video. Release Button to Stop Snapshot
<b>HDMI Output Resolution</b>	4K@30FPS 1080P@60FPS/30FPS 720P@60FPS
<b>Video Start and Stop Function</b>	Short Press the Power Button (A) to Pause or Continue Video Recording
<b>USB Camera Resolution</b>	H.264: 4K@30FPS, 1080P@120FPS, 720P@60FPS (Dependency on Sensor Type and UVC Protocol)  MJPG: 5760x3240@10FPS, 4000x3000@10FPS 4K@30FPS, 1080P@30FPS, 720P@30FPS YUY2: 480P@30FPS (Supports Modification of UVC Output on Configurations)
<b>USB Flash Drive</b>	USB Mode when Connected to Computer
<b>Inverted Mode</b>	By Placing a Configuration File in the Card, You Can Modify the Displayed or Captured file and Flip it 180 degrees
<b>WiFi Mode</b>	AP Mode, STA Mode Set WiFi Mode by Putting Configuration Files in the Card or Enter the Menu to Set This Item Through the Touch Screen
<b>Configuration IP Address</b>	By Placing a Configuration File in the Card, You Can Modify the IP and Gateway Address of the Camera. Default is Static IP. Optional on Dynamic IP.
<b>RTSP Video Stream Address</b>	By Placing a Configuration File in the Card, You Can Modify the RTSP video stream address. If There is No Configuration File in the Card, the Default Port is 554.

**KLT-G1M9 V6.2****iCatch V39 Ai-Powered Image Processing SoC Master Board****USB Type-C Interface:**

This interface supports USB standard 5V power input, which can power the master board and charge the battery (recommended 7.4V-7.7V battery). Connecting to a computer can directly read files in the TF card and use it as a USB flash drive. It can also be used as a PCCAM USB camera.

The USB interface retains one camera control serial port UART3 and one camera debugging serial port UART1 (the serial port function can be used with the G1-USB serial port debugging board).

**Connecting to the Computer USB Flash Drive Mode:**

Insert the TF card, connect the other end of the USB to the computer, and automatically enter the USB flash drive mode after booting by default.

**Connecting to the Computer PCCAM Mode:**

Insert the TF card, connect the other end of the USB to the computer, and automatically enter the USB flash drive mode after booting. Short press the OK button (A) to switch to PCCAM camera mode. (Right-click the computer "Computer", click the left button in the pop-up prompt box to enter "Management", "Device Manager", and you can see the name of the camera identified in "Image Device" camera. Open the camera tool "amcap.exe" to see the current device preview screen).

**Battery Power Supply:**

6.6V (low power shutdown) to 8.8V, 7.4-7.7V high-voltage and high-density batteries are recommended  
Special note: the battery power supply can support up to 12V; but this does not include the gimbal version, the stable power supply voltage of the gimbal version is 8V.

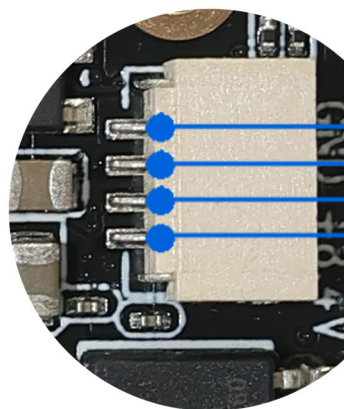
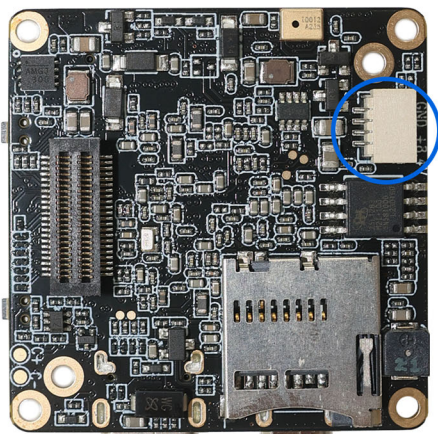

BAT -  
BAT +

Battery 7.7V-8.8V  
电池供电



**KLT-G1M9 V6.2****iCatch V39 Ai-Powered Image Processing SoC Master Board****Charge the Battery:**

Use a power adapter (5V2A recommended) to charge the battery of the machine. The red light will be on during charging and the green light will be on when fully charged.

**Camera Module:**

This interface can be used to expand multiple MIPI sensors, IR-CUT function, LED fill light, serial port UART2, battery power output, micro three-axis gimbal and other functions.

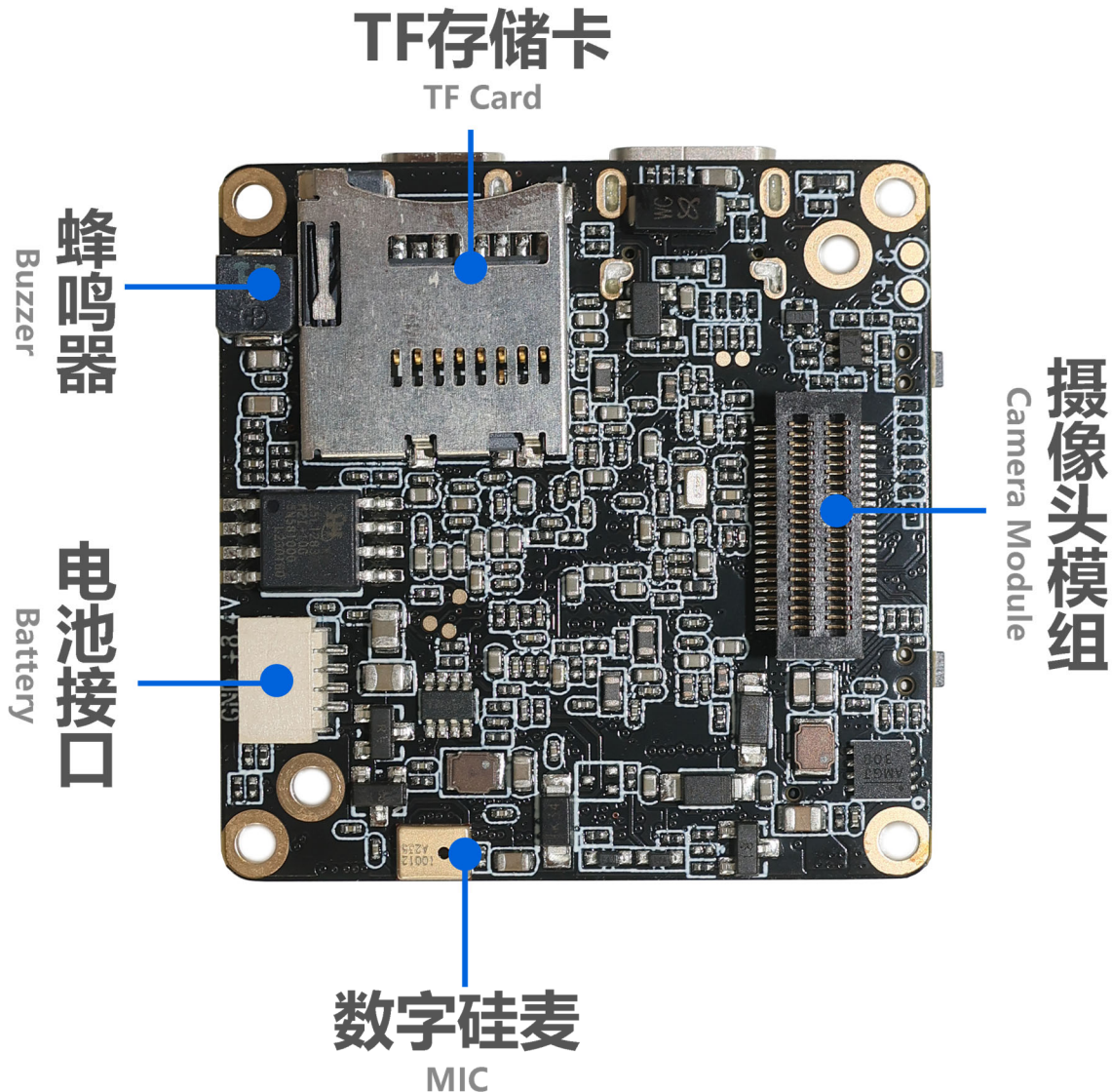



## KLT-G1M9 V6.2

### iCatch V39 Ai-Powered Image Processing SoC Master Board

#### Button Instructions:

Button	Mode or Status	Functional Operation
<b>Button A</b> Power Mode	Power ON / OFF	Long Press 1 Second Power ON / OFF
	Standby	Short Press on Switch Mode Video Recording, Snapshot, Playback, Settings
	Setting Mode (with Touch Screen)	Short Press to Scroll Down Menu (After Pressing Button B to Enter Setting)
	Video Recording	Short Press to Pause or Continue Recording
<b>Button B</b> Confirmation OK Video Recording	Standby	In Video Standby Mode, Long Press 3 Seconds to Turn ON / OFF WiFi Mode. Default WiFi is OFF. In Video Recording Mode, Short Press to Start Recording In Snapshot Mode, Short Press to Start Taking Photo Long Press to Start Continue Shooting Release to Stop Continue Shooting
	Video Recording	Short Press to Stop Recording and Save the File Long Press 2 Seconds (Less than 4 Seconds) to Take a Single Frame Shot, Release to Stop Taking Frame Shots Long Press 5 Seconds to Take Continues Frame Shots, Release to Stop Taking Frame Shots
	Setting Mode (with Touch Screen)	Short Press to Confirm and Enter Setting Mode Long Press 2 Seconds to Return Double-Click to Switch Between Settings: Photo / Video / System / 3-Axis Gimbal
	Playback Mode (with Touch Screen)	Short Press to Scroll Up Menu Double-Click to Play / Pause Video or Audio Files Click 3 Times to Mark or Unmark Files. If File is Marked, then the File is Locked and Not Erasable Long Press to Prompt Option to Delete Current File (Long Press to Delete, Short Press to Return) After Entering, Long Press Again to Delete
	Shutdown	Press and Hold to Enter the USB Burning Mode
<b>Reset Function</b>	Standby or Working	Press Button A and B at the Same Time to Shutdown



## KLT-G1M9 V6.2

### iCatch V39 Ai-Powered Image Processing SoC Master Board

#### LED Indicator Description:

Functions	Color	Power On	Video Mode	Video Recording	Photo Mode	Photo Snapshot	Playback Mode	Setting Mode
LED Indicator	Red	Always On	Always On	Flashing			Always On	
	Green				Always On	Flash Once	Always On	
	Blue						Always On	Always On

Note: When the device is powered without a TF card inserted, the function indicator light flashes yellow.

#### Buzzer Sound Description:

Operation Mode	Power On	Power Off	Switching Mode	Start Video Recording	Start Stop Recording	Photo Snapshot	Menu Setting	Menu Scroll Down	Exit Menu Setting
Buzzer Sound	3 Beeps	5 Beeps	1 Beep	1 Beep	2 Beeps	1 Beep	1 Beep	1 Beep	1 Beep

Special Note: When the touch screen is not in use, you can modify the setting parameters through the configuration file. Put the configuration file, such as "CameraConfig\_G1A.ini" (the specific configuration file name will vary depending on the lens module) in the root directory of the TF card, and you can modify the corresponding function options in the configuration file. After saving the changes, shut down the machine and restart it to take effect.





## KLT-G1WF V6.3 WiFi Expansion Board

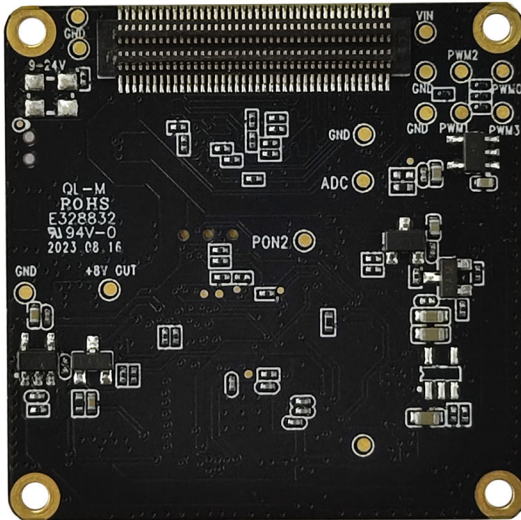

Front View

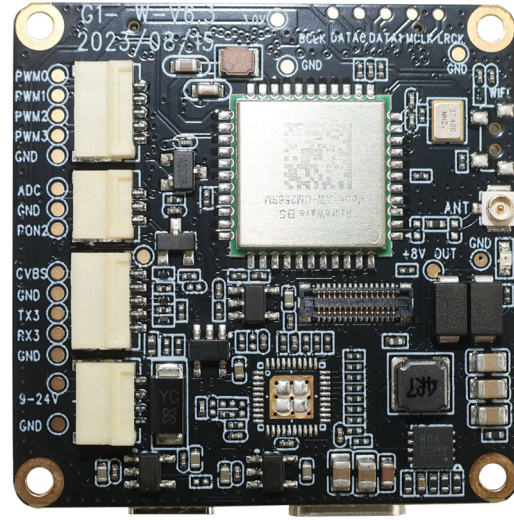

Back View

### Overview

WiFi expansion board is equipped with the AW CM256SM single-pass dual-band WiFi module, which supports the use of single-band 2.4GHz or 5GHz wireless WiFi functions. The board supports WiFi antenna, reserved WiFi button (Button C), serial port (UART3), etc.

PWM, ADC button, touch screen and other expansion interfaces included. The board PCB size is 38x38mm, and it must be used with our company's designated master board. This WiFi board can not work independently.



## KLT-G1WF V6.3 WiFi Expansion Board

### Specifications

<b>Model No.</b>	<b>KLT-G1WF V6.3</b>
<b>WiFi Module</b>	AW CM256SM
<b>Power Supply</b>	Supports 3 Power Supply Methods At The Same Time (1) 5V USB to Type-C Port Power Supply (2) 9V-24V WiFi Board Power Supply (3) 6.8V-8.4V Battery Power Supply (The 3-Axis Gimbal Version Does Not Support 5V USB)
<b>WiFi Frequency Bands</b>	2.4GHz or 5GHz (Dual Band Single Channel)
<b>Wireless Network Standards</b>	IEEE 802.11B/G/N/AC, WiFi Compliant
<b>2.4GHz Frequency Range</b>	2.400GHz - 2.472GHz (2.4GHz ISM Band)
<b>2.4GHz Channels</b>	2.4GHz: Channel 1 - Channel 13
<b>2.4GHz Transmission Rate</b>	2 - 3 Megabytes
<b>2.4GHz Transmission Distance</b>	50 Meters (No Disruption)
<b>5GHz Frequency Range</b>	5.150GHz - 5.825GHz (5GHz ISM Band)
<b>5GHz Channels</b>	5GHz: Channel 1 - Channel 13
<b>5GHz Transmission Rate</b>	6 - 8 Megabytes
<b>5GHz Transmission Distance</b>	30 Meters (No Disruption)
<b>CVBS (TV-Out)</b>	720 x 576
<b>CVBS Standards</b>	NTSC / PAL (TV-Out)
<b>Serial Port / UART</b>	RX3, TX3, GND
<b>ADC Button</b>	Up, Down, Left, Right, OK 5-Way ADC Buttons Power Button
<b>Operating Temperature</b>	-10°C to +60°C Without Housing
<b>Storage Temperature</b>	-20°C to +80°C
<b>Humidity</b>	20% to 80%
<b>PCB Dimensions</b>	38 x 38 mm
<b>PCB Screw Hole Spacing</b>	34 mm
<b>PCB Screw Hole Diameter</b>	2 mm
<b>Extendable Functions</b>	PWM, ADC Buttons, WiFi Board Power Supply UART3 Serial Port, Touch Screen, Other Interfaces



## KLT-G1WF V6.3 WiFi Expansion Board

### Hardware Interface Function Description

AW CM256SM single-pass dual-band WiFi module supports single-band 2.4GHz or 5GHz wireless WiFi function, and adopts the first generation IPEX universal copper standard antenna.

In the video mode standby state, long press the master board Button B, that is, long press the motherboard shooting button for 3S to turn on WiFi. The red light flashes when WiFi is turned on, and the red light is always on after the connection is successful.

**PWM接口**  
PWM port

**无线WiFi模组**  
WiFi Module

**ADC  
5向按键**  
ADC Five Keys

**控制串口**  
Control  
(uart) port

**WiFi天线**  
WiFi Antenna

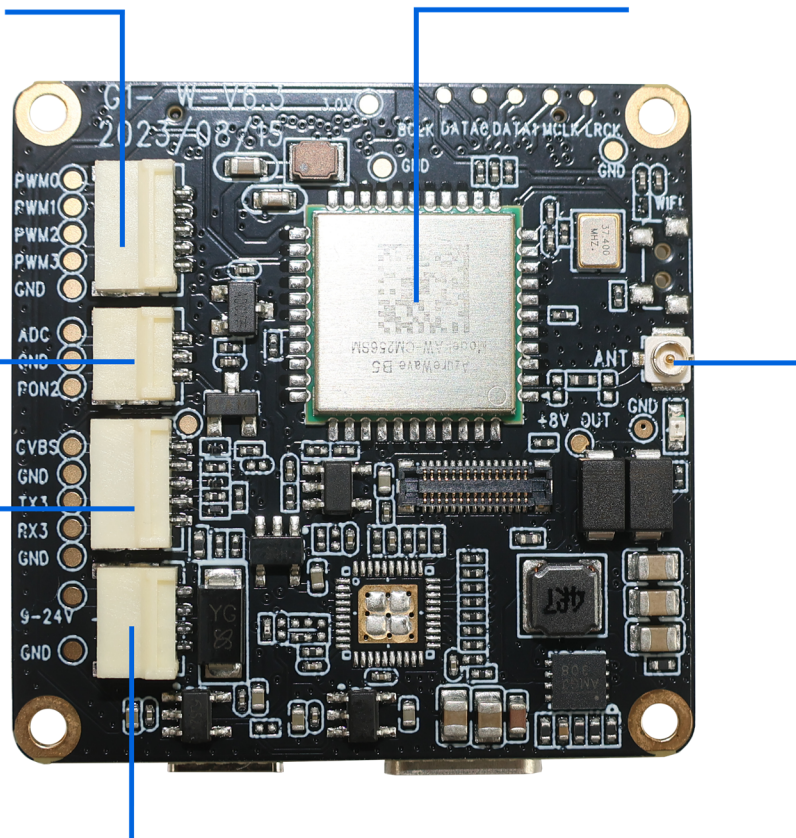

**9~24Vwifi板上电控制相机开机**

The wifi board power supply control camera is turned on





## KLT-G1WF V6.3 WiFi Expansion Board

The PWM function interface, which can be used to control camera mode switching, photo taking, video recording and other functions.

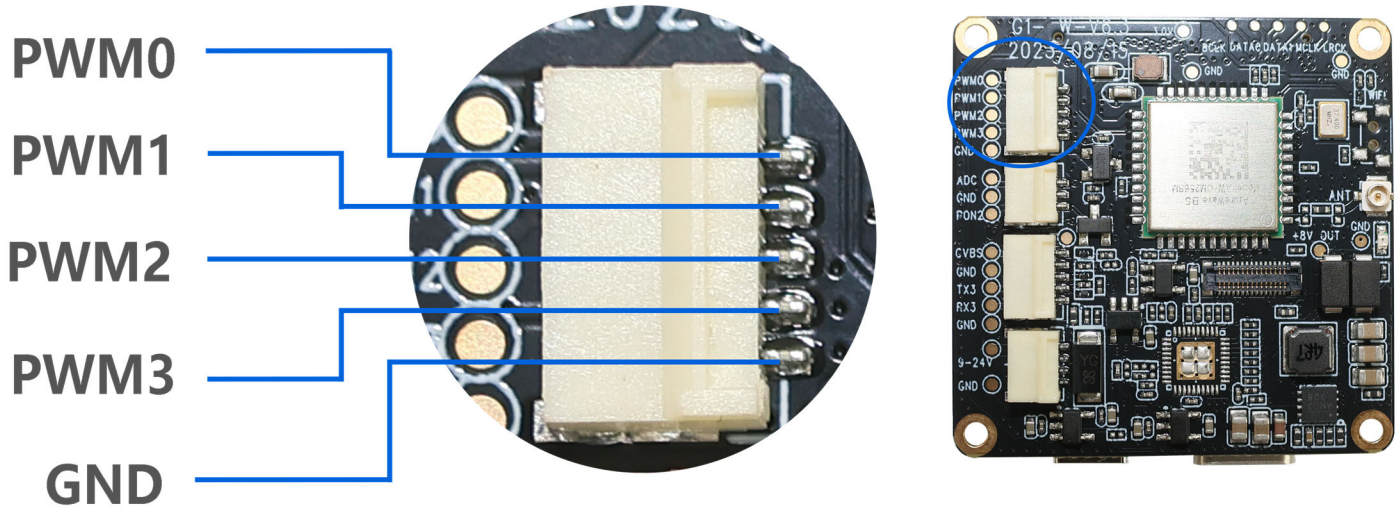

Supports one ADC button interface, which can be connected to five buttons: up, down, left, right, and OK, to control the camera's recording, taking pictures, turning on WiFi, etc. Supports external buttons to control the camera's power on and off.

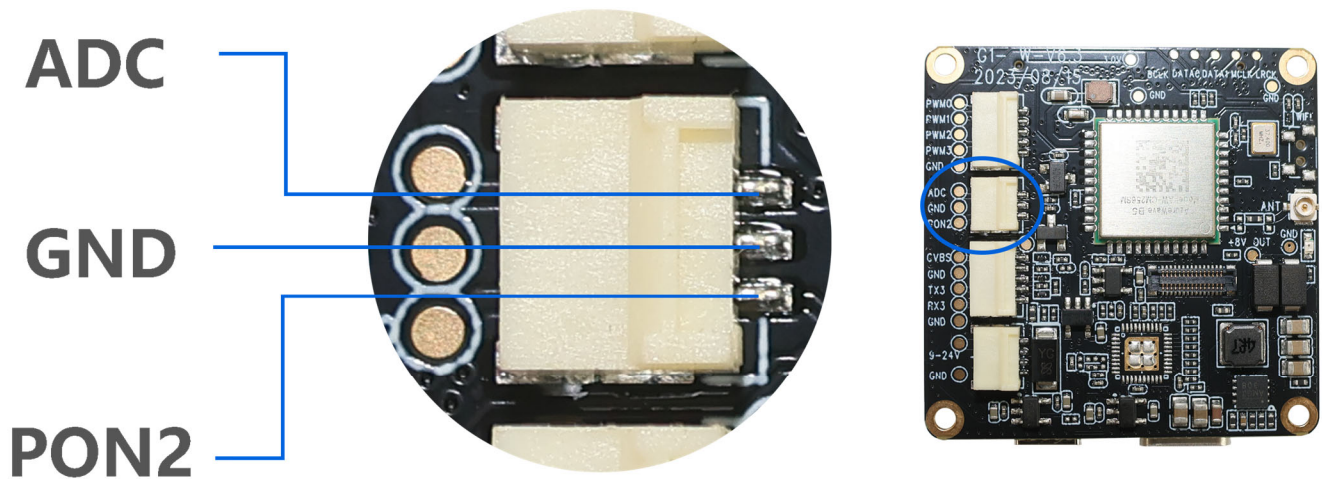



## KLT-G1WF V6.3 WiFi Expansion Board

Supports one analog video CVBS (TV-OUT) signal output, with RX3 and TX3 reserved ports, and the camera can be set and controlled through this serial port.

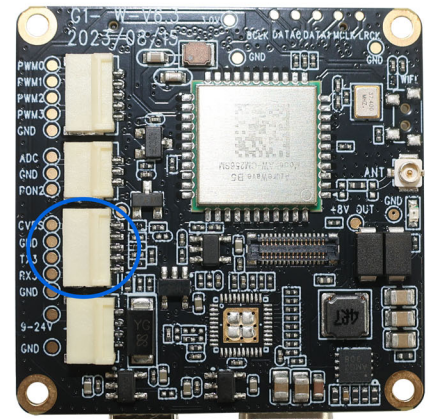
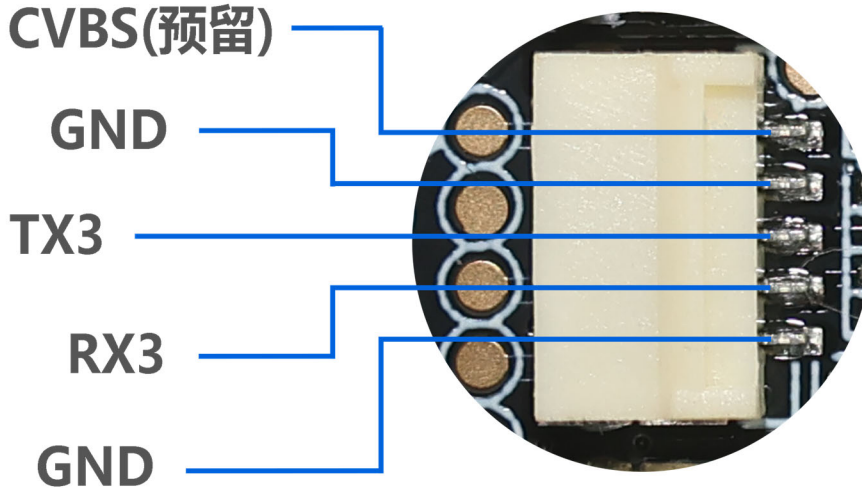

The camera can be powered on automatically using 9V-24V power supply; the master board supports three-way simultaneous use, namely WiFi board power supply, motherboard battery power supply, and Type-C USB power supply. It can also be used with a single power supply.

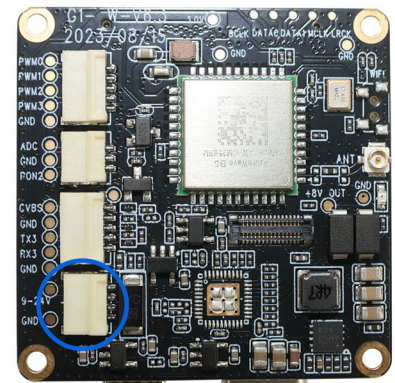
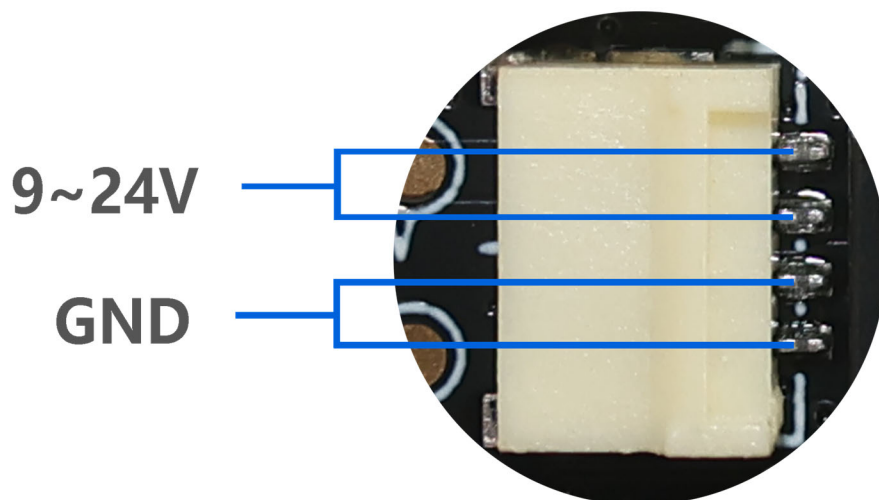

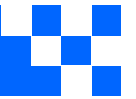

## KLT-G1WF V6.3 WiFi Expansion Board

Special note:

The three-axis gimbal does not support 5V USB power supply alone. The battery power supply can support up to 12V; but this does not include the gimbal version, the stable power supply voltage of the battery for gimbal version is 8V.

### wifi板连接主板扩展板接口 wifi board connect to main board

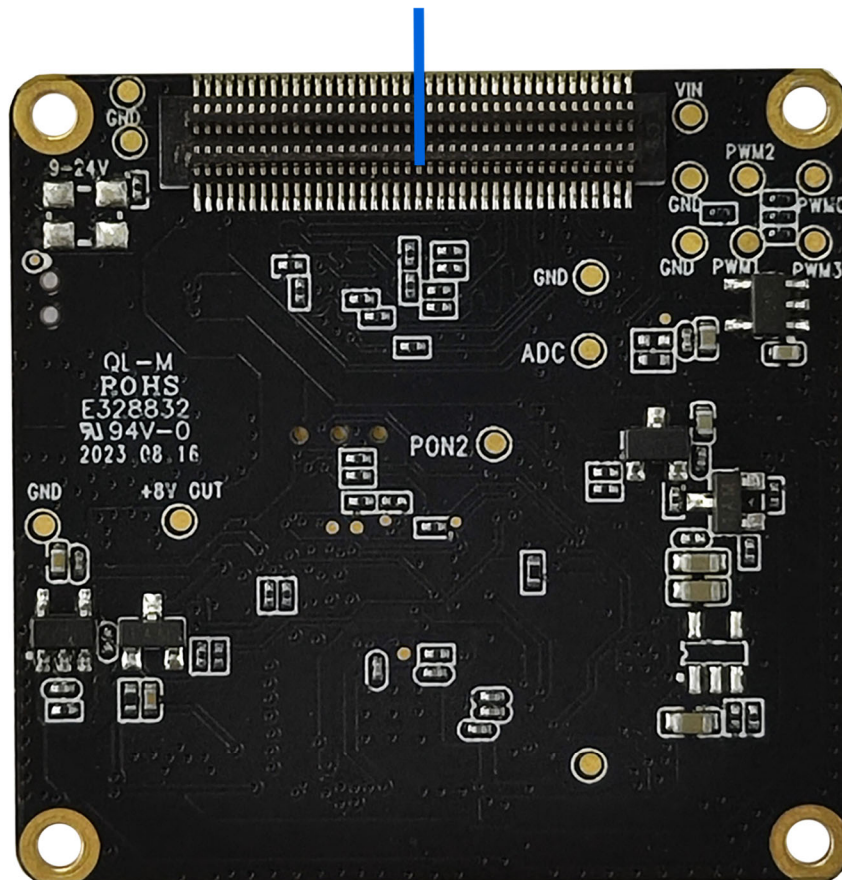



## KLT-CMAOIS-IMX258 V1.0

### 13MP Sony IMX258 Auto Focus OIS Anti-Shake Camera Module

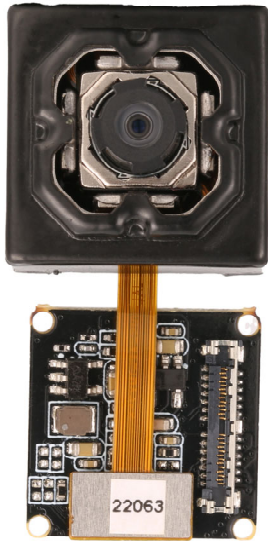

Front View



Back View

### Overview

The KLT-CMAOIS-IMX258 V1.0 optical image stabilization (OIS) camera module uses the Sony IMX258 (1/3.06 inch) image sensor, with a color square pixel display and up to 13 megapixels with 1.12um pixel size.

When used with the master board, it can support shooting 13MP still pictures, and support up to 4K@60FPS (differential), 4K@30FPS video shooting. The world's smallest optical image stabilization module can correct slight jitter within 4 degrees.





## KLT-CMAOIS-IMX258 V1.0

### 13MP Sony IMX258 Auto Focus OIS Anti-Shake Camera Module

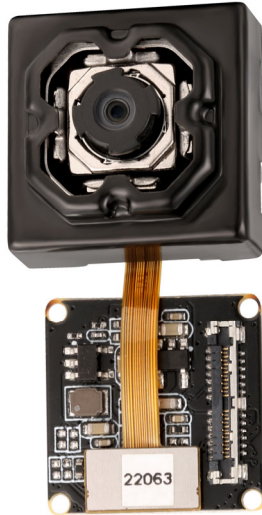

Top View



Side View



Bottom View

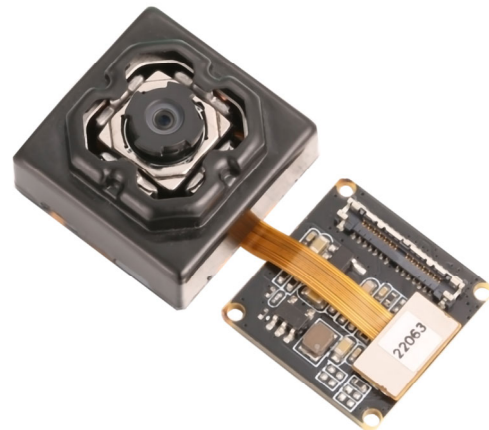

Isometric View



## KLT-CMAOIS-IMX258 V1.0

### 13MP Sony IMX258 Auto Focus OIS Anti-Shake Camera Module

#### Specifications

<b>Model No.</b>	<b>KLT-CMAOIS-IMX258 V1.0</b>
<b>Image Sensor</b>	IMX258
<b>Image Sensor Type</b>	CMOS
<b>Effective Pixels</b>	13 Megapixels
<b>Sensor Size</b>	1/3.06"
<b>Pixel Size</b>	1.12 um x 1.12 um
<b>Gimbal Image Stabilization</b>	OIS - Optical Image Stabilizer
<b>OIS Anti-Shake Control</b>	Turn ON, Turn OFF
<b>Video Frame Rate</b>	4K@24/25/30/FPS, 4K@48/50/60FPS (Differential) 2.7K@24/25/30/48/50/60FPS 1080P@24/25/30/48/50/60/120FPS 720P@24/25/30/48/50/60/120/240FPS
<b>Video Slow Motion</b>	OFF, 4K2X, 1080P4X, 720P8X
<b>Photo Resolution (with Master Board)</b>	20MP (5200x3900) (Differential) 13MP (4160x3120) 12MP (4000x3000) 10MP (3648x2736) 8MP (3264x2448) 5MP (2592x1944) 3MP (2048x1536) 2MP (1920x1080)
<b>Operating Temperature</b>	-10°C to +60°C
<b>Storage Temperature</b>	-20°C to +80°C
<b>Humidity</b>	20% to 80%
<b>PCB Dimensions</b>	33 x 32 mm
<b>Module Size</b>	33 x 32 x 14 mm
<b>PCB Screw Hole Spacing</b>	13 x 13 mm
<b>PCB Screw Hole Diameter</b>	2 mm



## KLT-CMAOIS-IMX258 V1.0

### 13MP Sony IMX258 Auto Focus OIS Anti-Shake Camera Module

#### Lens Specifications

<b>EFL (Focal Length)</b>	2.35 mm
<b>F. No.</b>	2.40
<b>Diagonal View Angle (DFOV)</b>	117.0° (DFOV)
<b>Lens Construction</b>	6P
<b>OIS Compensation Angle</b>	< +/- 4°
<b>Horizontal View Angle (HFOV)</b>	> 21dB
<b>Distortion</b>	<-10.5%

## [Product Brief]

Ver.1.0

# IMX258

Diagonal 5.867 mm (Type 1/3.06) 13Mega-Pixel CMOS Image Sensor with Square Pixel for Color Cameras

---

### Description

IMX258 is a diagonal 5.867mm (Type 1/3.06) 13 Mega-pixel CMOS active pixel type stacked image sensor with a square pixel array. It adopts Exmor R<sup>SM</sup> technology to achieve high speed image capturing by column parallel A/D converter circuits and high sensitivity and low noise image (comparing with conventional CMOS image sensor) through the backside illuminated imaging pixel structure. R, G, and B pigment primary color mosaic filter is employed. By introducing spatially multiplexed exposure technology, high dynamic range still pictures and movies are achievable. It

equips an electronic shutter with variable integration time. It operates with three power supply voltages: analog 2.7 V, digital 1.2 V and 1.8 V for input/output interface and achieves low power consumption.

In addition, this product is designed for use in cellular phone and tablet pc. When using this for another application, Sony does not guarantee the quality and reliability of product. Therefore, don't use this for applications other than cellular phone and tablet pc. Consult your Sony sales representative if you have any questions.

---

### Functions and Features

- ◆ Back-illuminated and stacked CMOS image sensor Exmor R<sup>SM</sup>
- ◆ Phase Detection pixel data output for Phase Detection Auto Focus
- ◆ High Dynamic Range (HDR) mode with raw data output.
- ◆ High signal to noise ratio (SNR).
- ◆ Full resolution @30fps (Normal / HDR). 4K2K @30fps (Normal / HDR) 1080p @60fps (Normal )
- ◆ Output video format of RAW10/8.
- ◆ Pixel binning readout and V sub-sampling function.
- ◆ Independent flipping and mirroring.
- ◆ CSI-2 serial data output (MIPI 2lane/4lane, Max. 1.3Gbps/lane, D-PHY spec. ver. 1.1 compliant)
- ◆ 2-wire serial communication.
- ◆ Two PLLs for independent clock generation for pixel control and data output interface.
- ◆ Dynamic Defect Pixel Correction.
- ◆ Fast mode transition. (on the fly)
- ◆ Dual sensor synchronization operation.
- ◆ 4K bit of OTP ROM for users.
- ◆ Built-in temperature sensor.

**Device Structure**

- ◆ CMOS image sensor
- ◆ Image size : Diagonal 5.867 mm (Type 1/3.06)
- ◆ Total number of pixels : 4224 (H) × 3192 (V) approx. 13.48 M pixels
- ◆ Number of effective pixels : 4224 (H) × 3144 (V) approx. 13.28 M pixels
- ◆ Number of active pixels : 4208 (H) × 3120 (V) approx. 13.13 M pixels
- ◆ Chip size : 5.990 mm (H) × 3.908 mm (V)
- ◆ Unit cell size : 1.12 μm (H) × 1.12 μm (V)
- ◆ Substrate material : Silicon

System block diagram

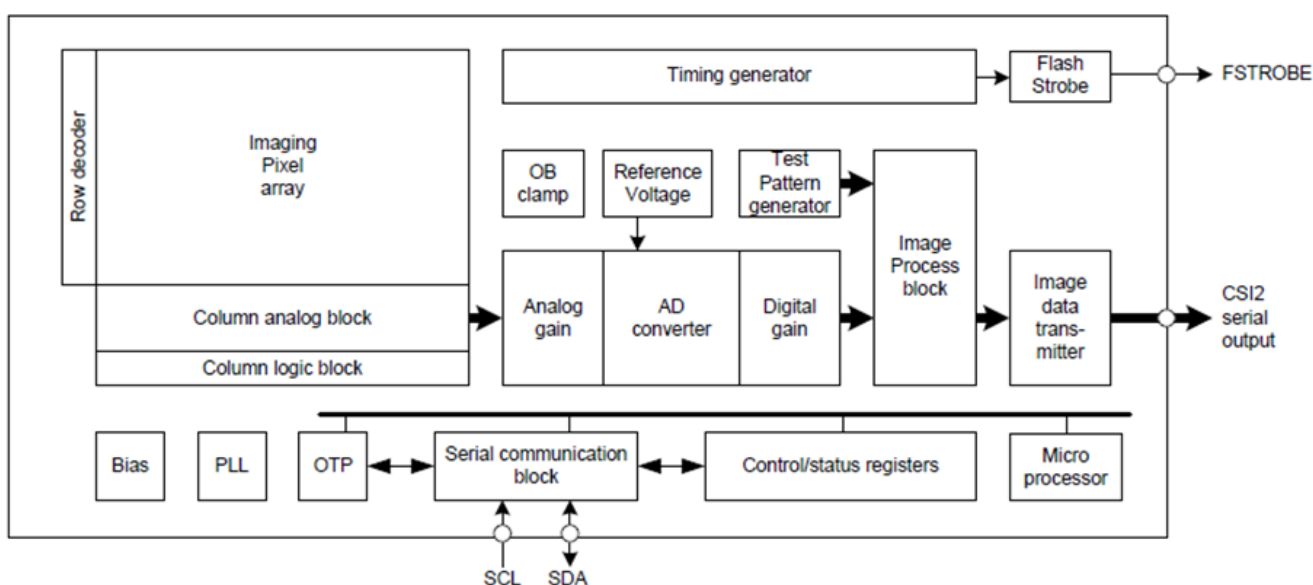

**Exmor RS**

\* Exmor RS is a trademark of Sony Corporation. The Exmor RS is a Sony's CMOS image sensor with high-resolution, high-performance and compact size by replacing a supporting substrate in Exmor R™ which changed fundamental structure of Exmor™ pixel adopted column parallel A/D converter to back-illuminated type, with layered chips formed signal processing circuits.





## Cameras Applications



Automotive Driver Pilot



Live Streaming



Video Conference



Eye Tracker Biometric Detection



Machine Vision



Agricultural Monitor

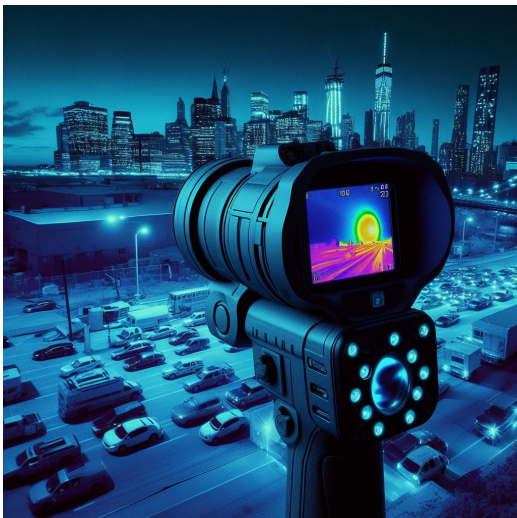

Night Vision Security



Drone and Sports Eagle Eyes



Interactive Pet Camera





your **BEST** camera module partner

## Cameras Applications

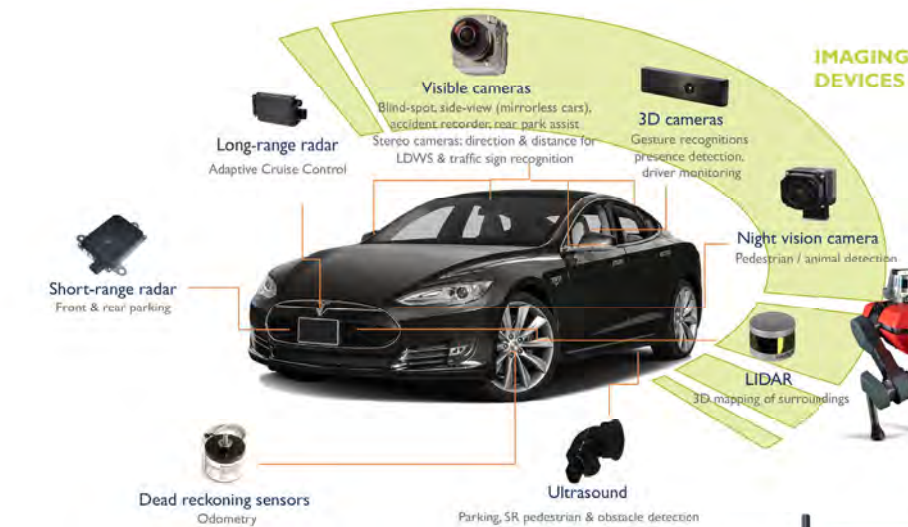



## Camera Module Pinout Definition Reference Chart

OmniVision	Sony	Samsung	On-Semi	Aptina	Himax	GalaxyCore	PixArt	SmartSens	Sensors
Pin Signal									
Description									
DGND	GND								
AGND									
PCLK	DCK								
XCLR	PWDN	XSHUTDOWN	STANDBY						
MCLK	XVCLK	XCLK	INCK						
RESET	RST								
NC	NULL								
SDA	SIO_D	SIOD							
SCL	SIO_C	SIOC							
VSYNC	XVS	FSYNC							
HREF	XHS								
DOVDD									
AFVDD									
AVDD									
DVDD									
STROBE	FSTROBE								
FSIN									
SID									
ILPWM									
FREX									
GPIO									
SLASEL									
AFEN									
<b>MIPI Interface</b>									
MDN0	DN0	MD0N	DATA_N	DMO1N					
MDP0	DP0	MD0P	DATA_P	DMO1P					
MDN1	DN1	MD1N	DATA2_N	DMO2N					
MDP1	DP1	MD1P	DATA2_P	DMO2P					
MDN2	DN2	MD2N	DATA3_N	DMO3N					
MDP2	DP2	MD2P	DATA3_P	DMO3P					
MDN3	DN3	MD3N	DATA4_N	DMO4N					
MDP3	DP3	MD3P	DATA4_P	DMO4P					
MCN	CLKN	CLK_N	DCKN						
MCP	CLKP	MCP	CLK_P	DCKN					
<b>DVP Parallel Interface</b>									
D0	DO0	Y0							
D1	DO1	Y1							
D2	DO2	Y2							
D3	DO3	Y3							
D4	DO4	Y4							
D5	DO5	Y5							
D6	DO6	Y6							
D7	DO7	Y7							
D8	DO8	Y8							
D9	DO9	Y9							
D10	DO10	Y10							
D11	DO11	Y11							



## Camera Reliability Test

Reliability Inspection Item		Testing Method	Acceptance Criteria	
Category	Item			
Environmental	Storage Temperature	High 60°C 96 Hours	Temperature Chamber	No Abnormal Situation
		Low -20°C 96 Hours	Temperature Chamber	No Abnormal Situation
	Operation Temperature	High 60°C 24 Hours	Temperature Chamber	No Abnormal Situation
		Low -20°C 24 Hours	Temperature Chamber	No Abnormal Situation
	Humidity	60°C 80% 24 Hours	Temperature Chamber	No Abnormal Situation
	Thermal Shock	High 60°C 0.5 Hours Low -20°C 0.5 Hours Cycling in 24 Hours	Temperature Chamber	No Abnormal Situation
Physical	Drop Test (Free Falling)	Without Package 60cm	10 Times on Wood Floor	Electrically Functional
		With Package 60cm	10 Times on Wood Floor	Electrically Functional
	Vibration Test	50Hz X-Axis 2mm 30min	Vibration Table	Electrically Functional
		50Hz Y-Axis 2mm 30min	Vibration Table	Electrically Functional
		50Hz Z-Axis 2mm 30min	Vibration Table	Electrically Functional
	Cable Tensile Strength Test	Loading Weight 4 kg 60 Seconds Cycling in 24 Hours	Tensile Testing Machine	Electrically Functional
Electrical	ESD Test	Contact Discharge 2 KV	ESD Testing Machine	Electrically Functional
		Air Discharge 4 KV	ESD Testing Machine	Electrically Functional
	Aging Test	On/Off 30 Seconds Cycling in 24 Hours	Power Switch	Electrically Functional
	USB Connector	On/Off 250 Times	Plug and Unplug	Electrically Functional







Inspection Item		Inspection Method	Standard of Inspection		
Category	Item				
Appearance	FPC/ PCB	Color	The Naked Eye	Major Difference is Not Allowed.	
		Be Torn/Chopped	The Naked Eye	Copper Crack Exposure is Not Allowed.	
		Marking	The Naked Eye	Clear, Recognizable (Within 30cm Distance)	
	Holder	Scratches	The Naked Eye	The Inside Crack Exposure is Not Allowed	
		Gap	The Naked Eye	Meet the Height Standard	
		Screw	The Naked Eye	Make Sure Screws Are Presented (If Any)	
		Damage	The Naked Eye	The Inside Crack Exposure is Not Allowed	
	Lens	Scratch	The Naked Eye	No Effect On Resolution Standard	
		Contamination	The Naked Eye	No Effect On Resolution Standard	
		Oil Film	The Naked Eye	No Effect On Resolution Standard	
		Cover Tape	The Naked Eye	No Issue On Appearance.	
	Function	Image	No Communication	Test Board	Not Allowed
			Bright Pixel	Black Board	Not Allowed In the Image Center
Dark Pixel			White board	Not Allowed In the Image Center	
Blurry			The Naked Eye	Not Allowed	
No Image			The Naked Eye	Not Allowed	
Vertical Line			The Naked Eye	Not Allowed	
Horizontal Line			The Naked Eye	Not Allowed	
Light Leakage			The Naked Eye	Not Allowed	
Blinking Image			The Naked Eye	Not Allowed	
Bruise			Inspection Jig	Not Allowed	
Resolution			Chart	Follows Outgoing Inspection Chart Standard	
Color			The Naked Eye	No Issue	
Noise			The Naked Eye	Not Allowed	
Corner Dark			The Naked Eye	Less Than 100px By 100px	
Color Resolution			The Naked Eye	No Issue	
Dimension	Height	The Naked Eye	Follows Approval Data Sheet		
	Width	The Naked Eye	Follows Approval Data Sheet		
	Length	The Naked Eye	Follows Approval Data Sheet		
	Overall	The Naked Eye	Follows Approval Data Sheet		





## KLT Package Solutions

KLT Camera Module

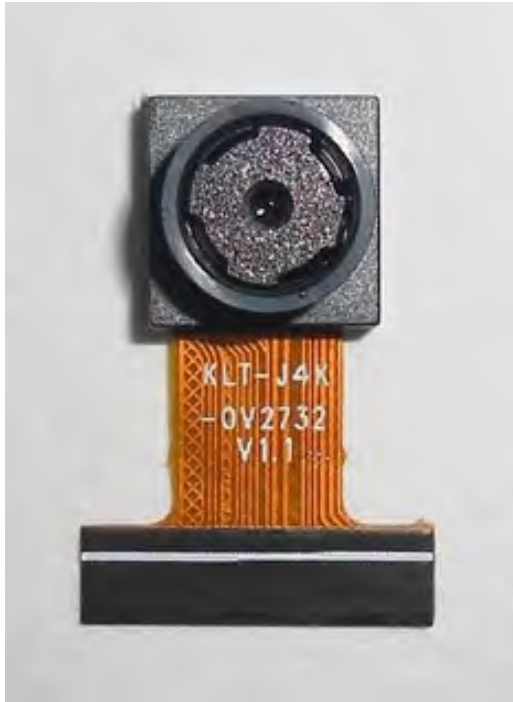

Complete with Lens Protection Film



Tray with Grid and Space



Place Cameras on the Tray

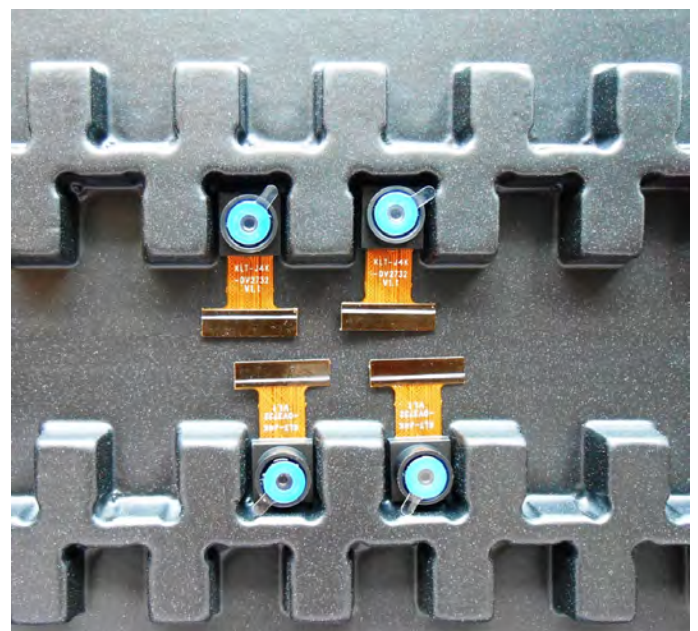

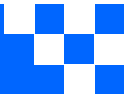

## Camera Modules Package Solution

Full Tray of Cameras

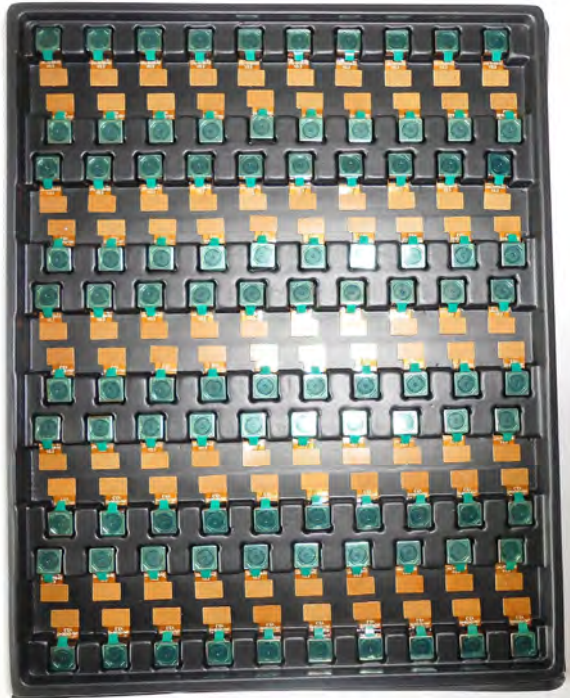

Cover Tray with Lid



Put Tray into Anti-Static Bag



Vacuum the Anti-Static Bag

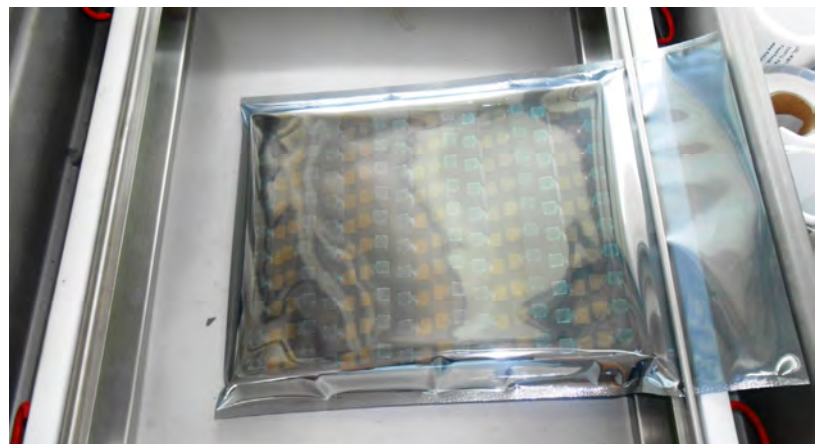





## Camera Modules Package Solution

Sealed Vacuum Bag with Labels

1. Model and Description 2. Quantity 3. Shipping Date 4. Caution





## Large Order Package Solution

Place Foam Sheets Between Trays



Foam Sheets are Slightly Larger than Trays



Place Foam Sheets and Trays into Box



Foam Sheets are Tightly Fitting Box







## Small Order Package Solution

Place Foam Sheets and Trays into Small Box



Foam Sheets are Nicely Fitting the Small Box



Package in Small Box for Shipment



Place Small Boxes into Larger Box





*your BEST camera module partner*

## Carbon Box Package Solution

Seal the Carbon Box

Final Package Labelled Box



### Carbon Box Ready for Shipment

1. Delivery Address and Phone No. 2. Box No. and Ship Date 3. Fragile Caution







## Sample Order Package Solution

Place Sample into Small Anti-Static Bag



Place Connectors into Small Ant-Static Bag



### Sample Labels on the Small Bag

1. Camera Module or Connector Model
2. Shipping Date and Quantity
3. Caution





## Connectors Large Order Package Solution

Connectors in a Wheel



Label Connectors in the Wheel



The Wheel is Perfectly Fitting the Box



Connectors Box Ready for Shipment







*your BEST camera module partner*

## Company Kai Lap Technologies (KLT)

Kai Lap Technologies Group Limited. (KLT) was established in 2009, a next-generation technology driven manufacturer specialized in research, design, and produce of audio and video products. KLT is occupying 20,000 square feet automated plants with 100 employees of annual throughput 30,000,000 units cameras.

KLT provides OEM, ODM design, contract manufacturing, and builds the camera products. You may provide the requirements to us, even with a hand draft, our sales and engineering work together to meet your needs. We consider ourselves your last-term partner in developing practical and innovative solutions.

Our team covers everything from initial concept development to mass produced product. KLT specializes in customized camera design, raw material, electronic engineering, firmware/software development, product testing, and packing design. Our experienced strategic supply systems offer a robust and dependable manufacturing capacity for orders of various sizes.

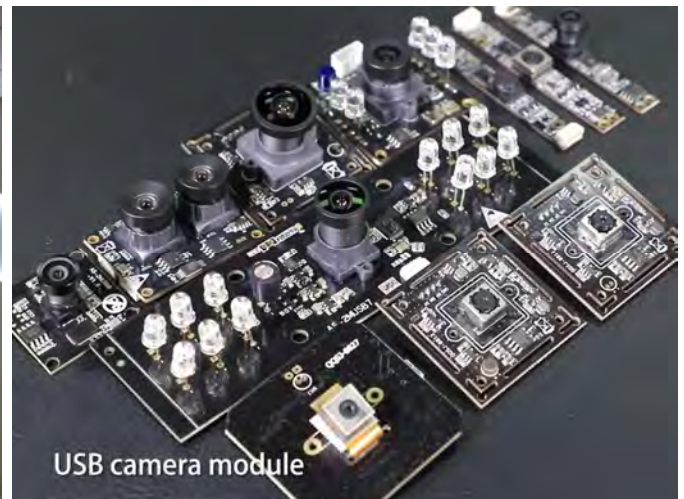

## Limited Warranty

KLT provides the following limited warranty if you purchased the Product(s) directly from KLT company or from KLT's website, [www.KaiLapTech.com](http://www.KaiLapTech.com). Product(s) purchased from other sellers or sources are not covered by this Limited Warranty. KLT guarantees that the Product(s) will be free from defects in materials and workmanship under normal use for a period of one (1) year from the date you receive the product ("Warranty Period").

For all Product(s) that contain or develop material defects in materials or workmanship during the Warranty Period, KLT will, at its sole option, either: (i) repair the Product(s); (ii) replace the Product(s) with a new or refurbished Product(s) (replacement Product(s) being of identical model or functional equivalent); or (iii) provide you a refund of the price you paid for the Product(s).

This Limited Warranty of KLT is solely limited to repair and/or replacement on the terms set forth above. KLT is not reliable or responsible for any subsequent events.







# CMOS CAMERA MODULES



*your BEST camera module partner*

## KLT Strength

### Powerful Factory



### Professional Service



### Promised Delivery



[www.KaiLapTech.com](http://www.KaiLapTech.com) [sales@KaiLapTech.com](mailto:sales@KaiLapTech.com) Tel: (852) 6908 1256 Fax: (852) 3017 6778

All rights reserved @ Kai Lap Technologies Group Ltd. Specifications subject to change without notice.